

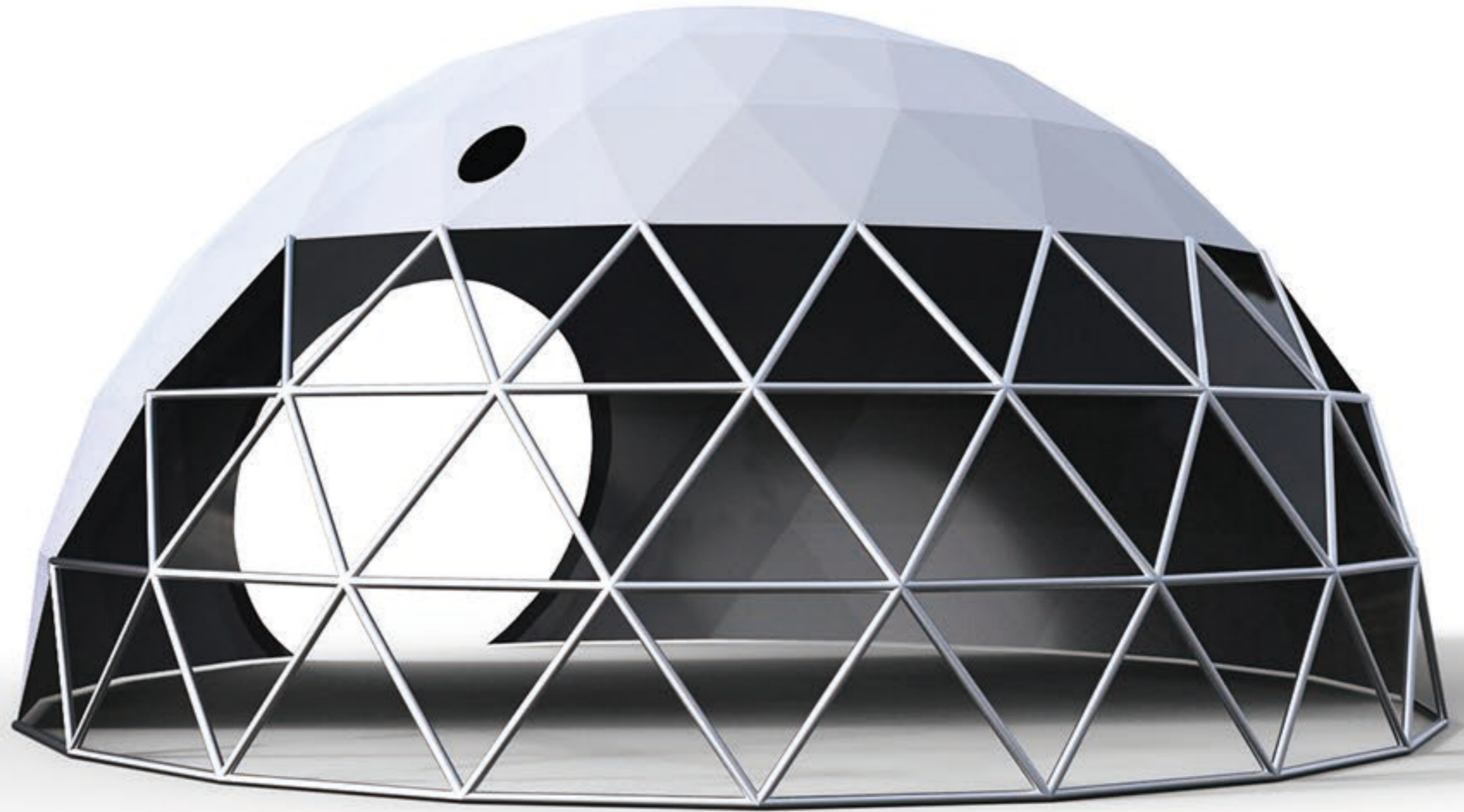

# SHELTER DOME

## ASSEMBLY GUIDE



## BEFORE INSTALLATION

- Prepare tools required for assembly. You will need Electric Wrench, Tool Box, Safety Belt and Scaffold.



Electric Wrench



Tool Box



Safety Belt



Scaffold

- Place all the components on a level, clean-swept ground. Check you have all the components and assembly drawings. Each pipe has two code stamps on both ends. You can distinguish and sort them out according to the assembly plan.

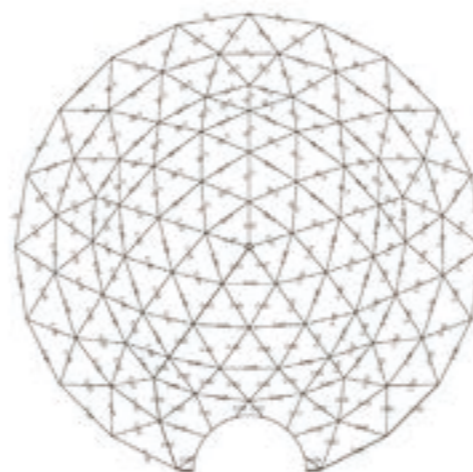

- Should you have any problems with the assembly or notice any damage to a package or some parts missing, please contact us by phone/WhatsApp: +86 139 2885 8552 or email: [admin@shelter-structures.com](mailto:admin@shelter-structures.com).

# INSTALLATION STEP

- 1 Confirm the flat ground where you want to erect your dome. It should cover a radius larger than your dome's in each direction from the center. Then draw a right circle on the ground to orient the base plate.

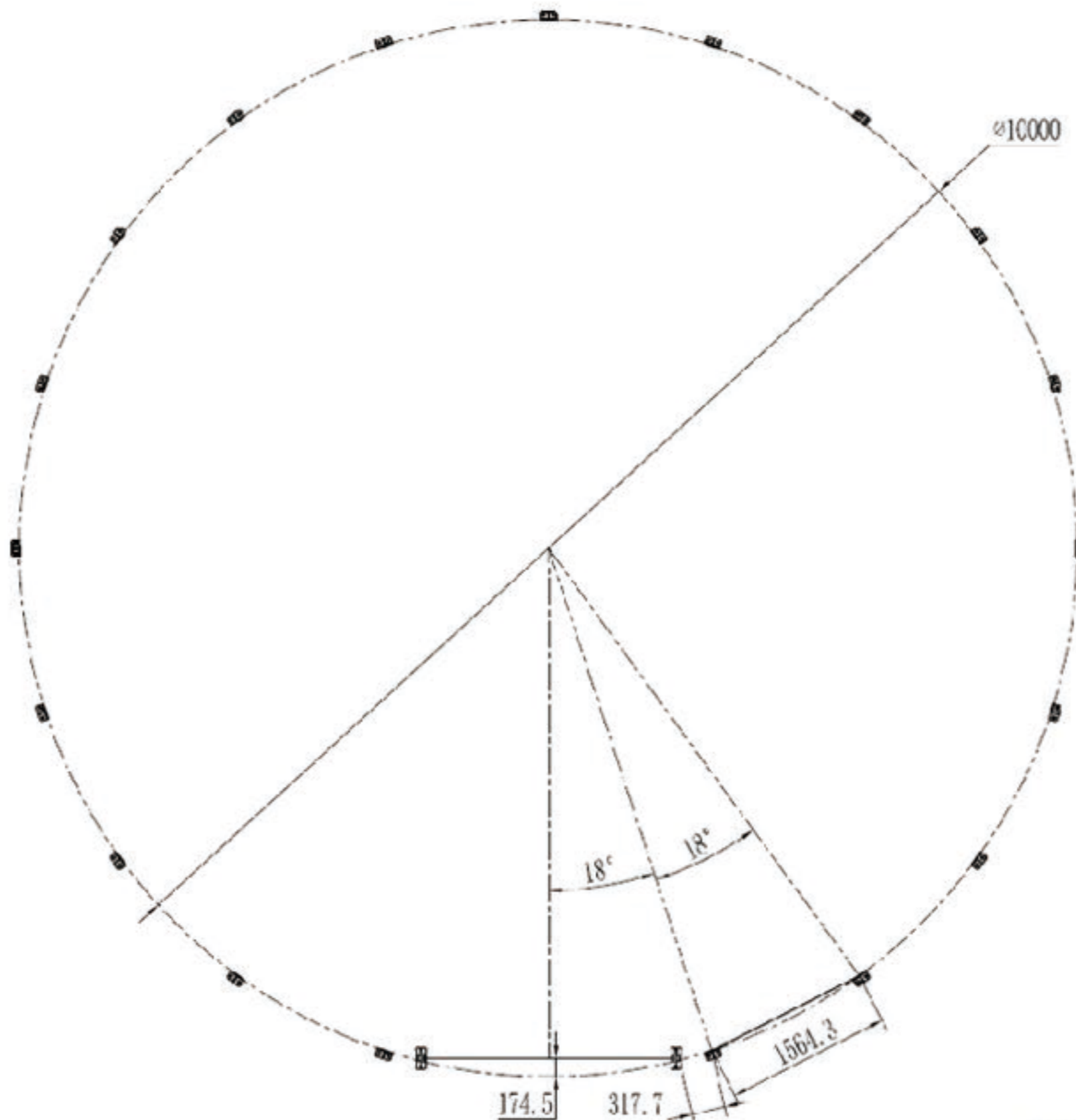

## INSTALLATION STEP

- 2 Mark the position of the door where you would like then start base installation from the foot you have placed. Lay the steel pipes along the circle you'd drawn and connect the base plate with the pipes.

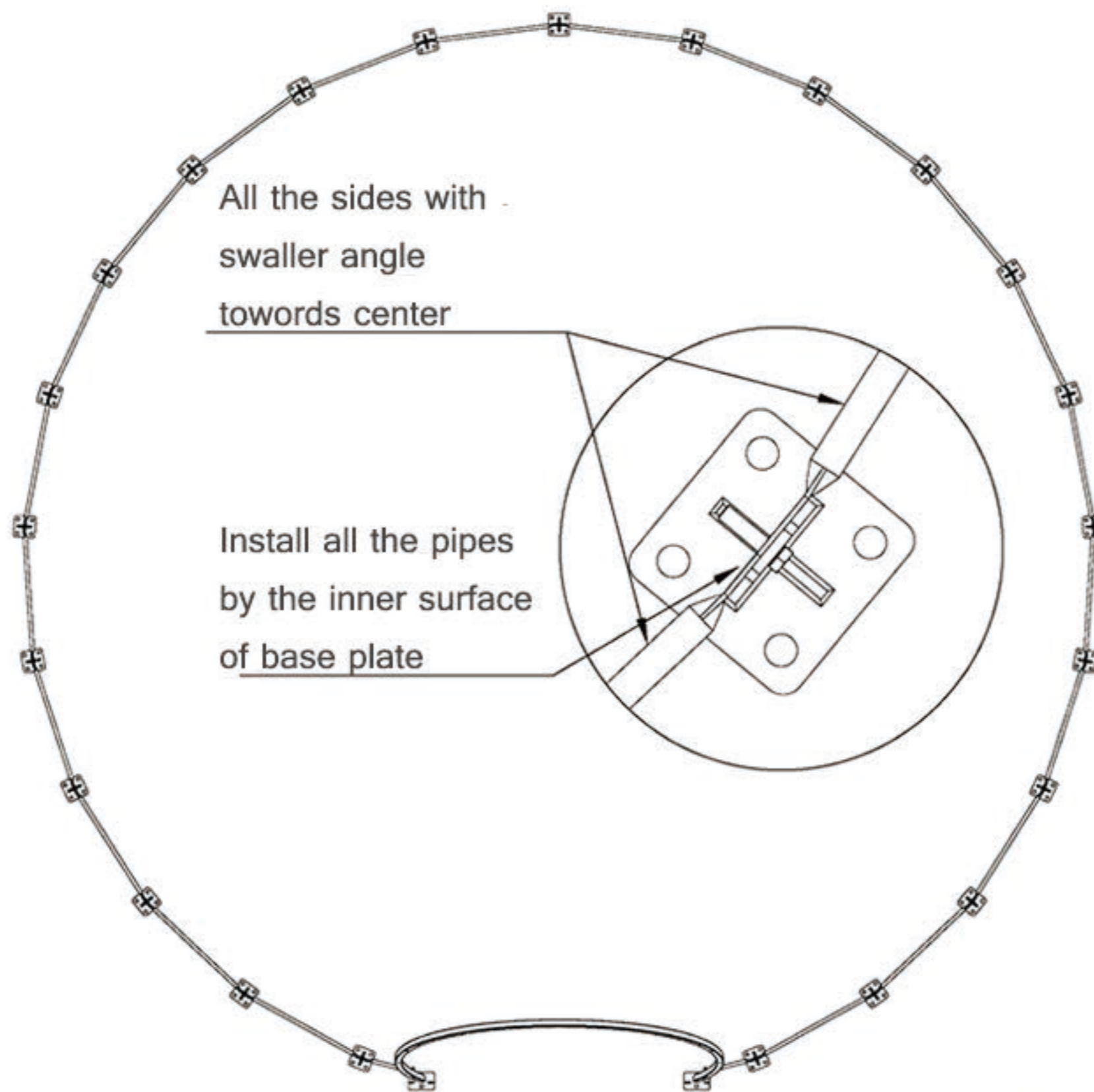

## INSTALLATION STEP

- 3 Prepare the first layer of pipes and lay them down on the ground. Connect each pipe with the connectors according to the code stamps. Double-check if all the pipes are installed by the inner surface of base plate and they are in the correct order.

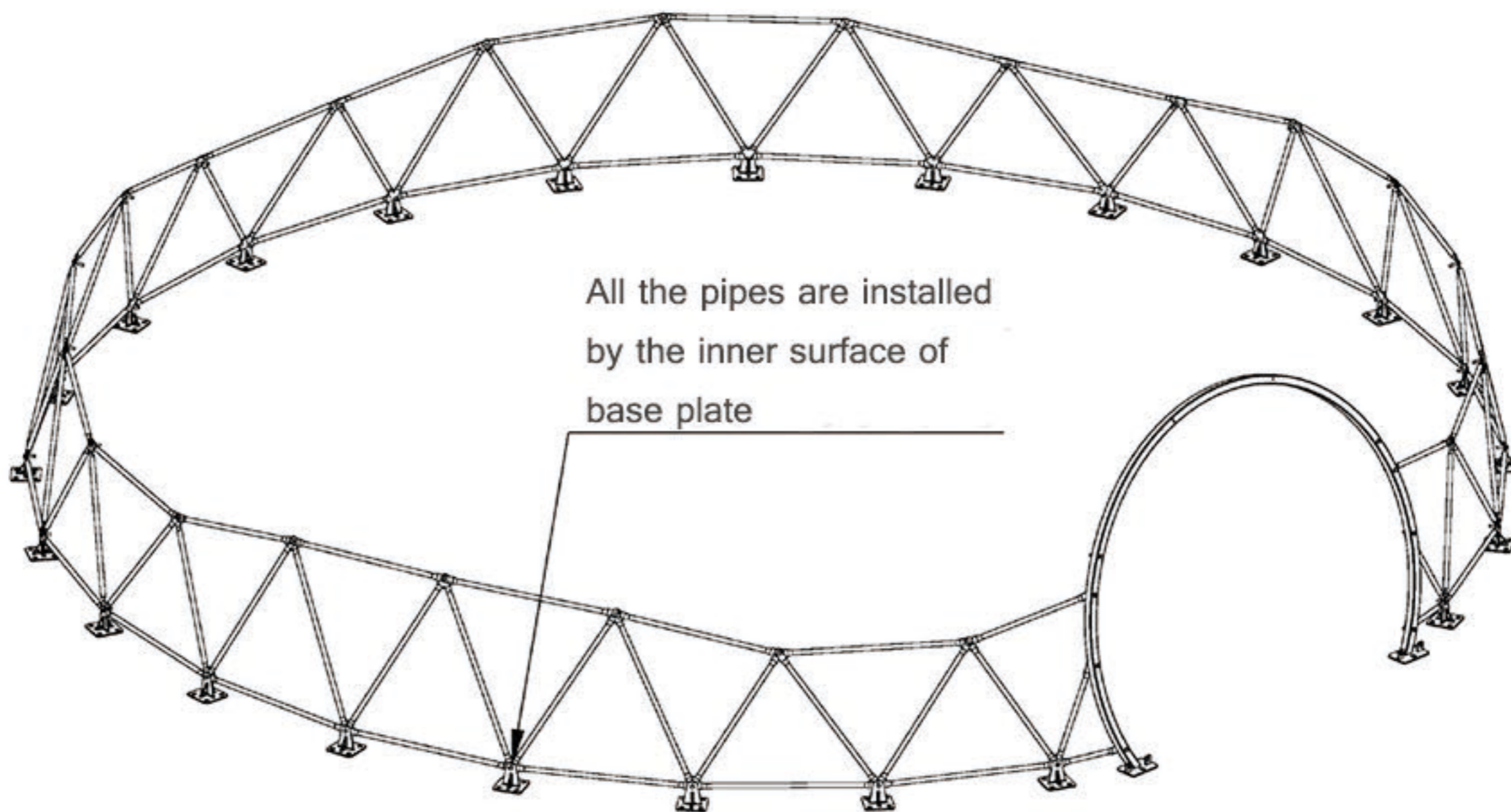

# INSTALLATION STEP

- 4 After finishing the first layer, you can prepare the second layer of pipes just as you did before. Attach them to their designated knots followed by the horizontal pipe layer. As shown, you should note the sequence of pipe to the designated knots.

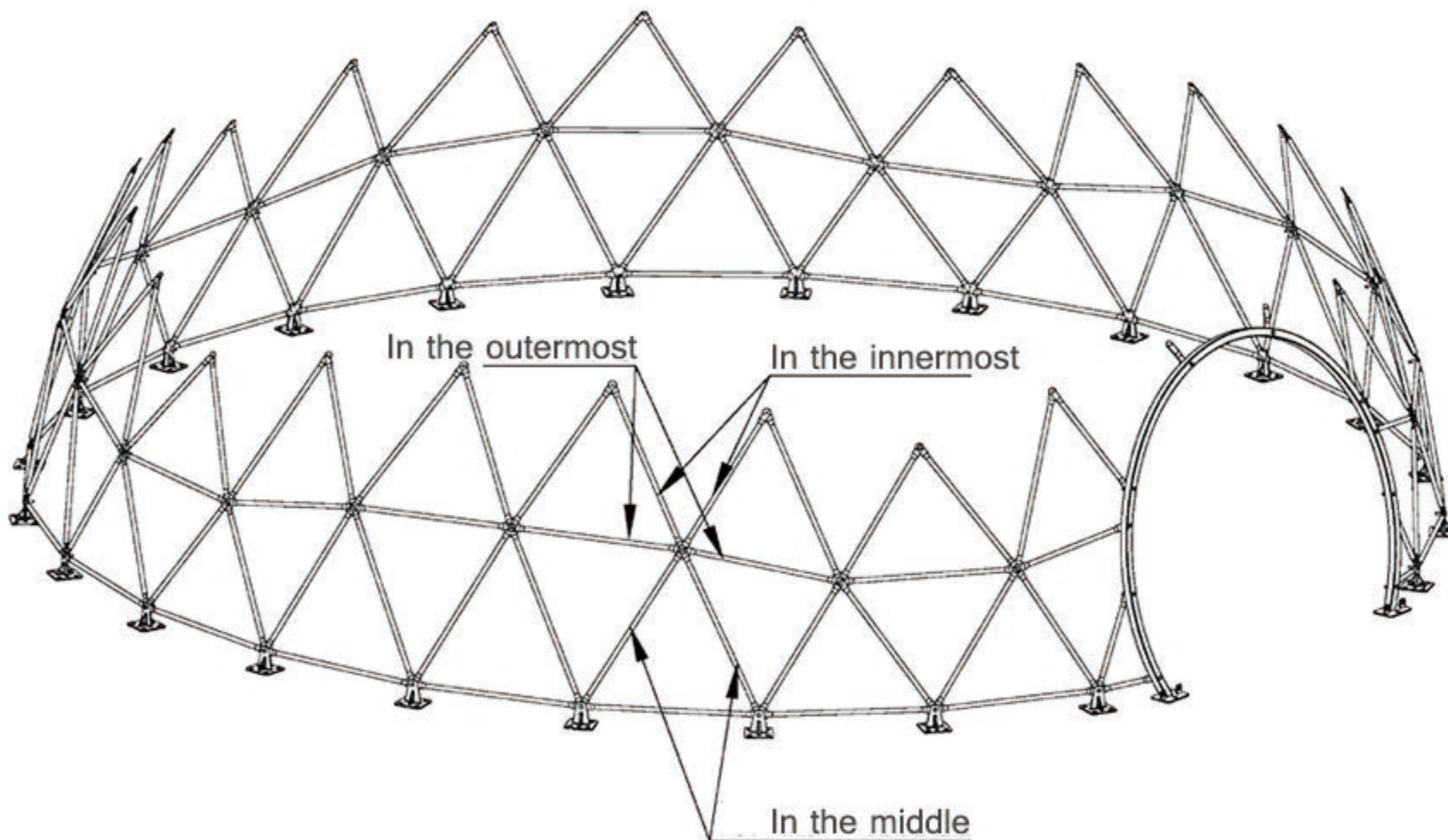

## INSTALLATION STEP

- 5** Then complete the second layer. Continue with the third layer just as you did before. It should be noted that do not tighten the connectors until you have the higher layer built. Repeatedly, you will easily finish the third, the fourth and the fifth layer.

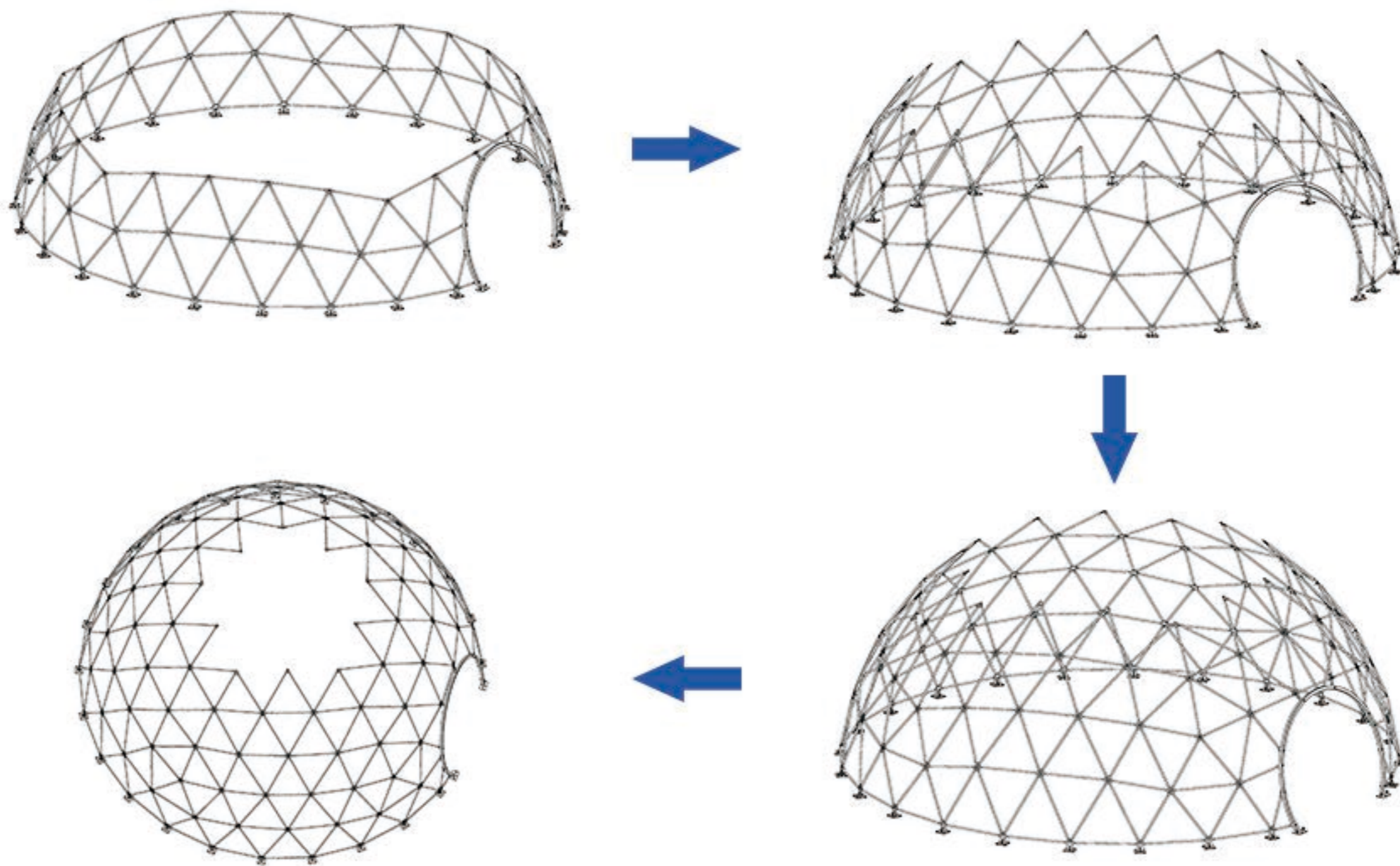

## INSTALLATION STEP

- 6 Assemble the roof part on the ground. With the help of a ladder or scaffold to put it on top to connect with adjacent knots. Finally you can get the whole framework. Make sure all the connectors are tight.

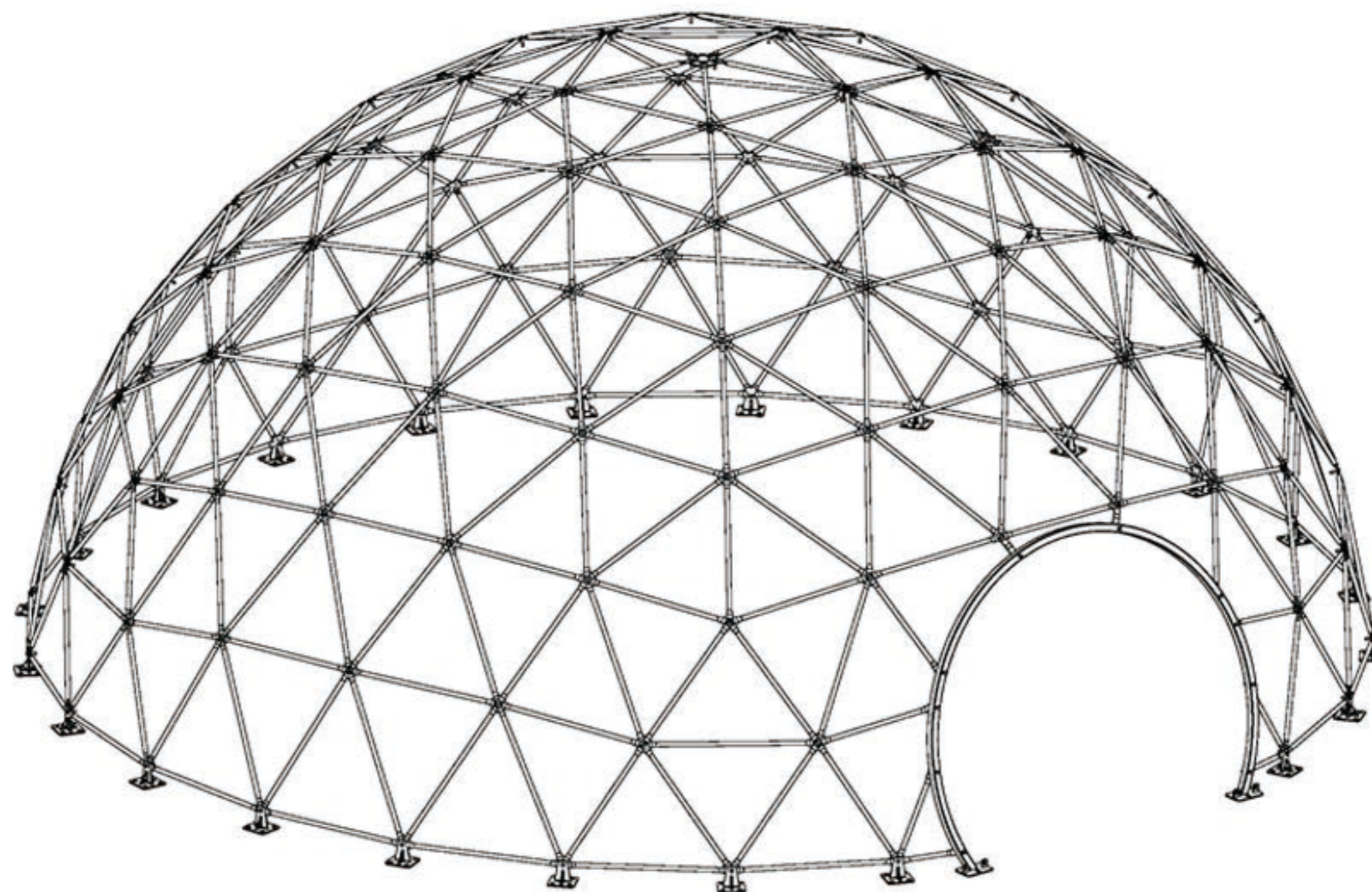



# INSTALLATION STEP

**7** Connect the arch to the dome frame to be the entrance. Adjust the framework to the right position. Then you can fix the base plate to the ground in the proper way.

For concrete floor, fix the dome using expansion bolt; for soft land like mud and grassland, pin the dome using steel stake; for any surface where can not be used the above two method, you can pin the dome to the ground using loading platform with ballast on it.

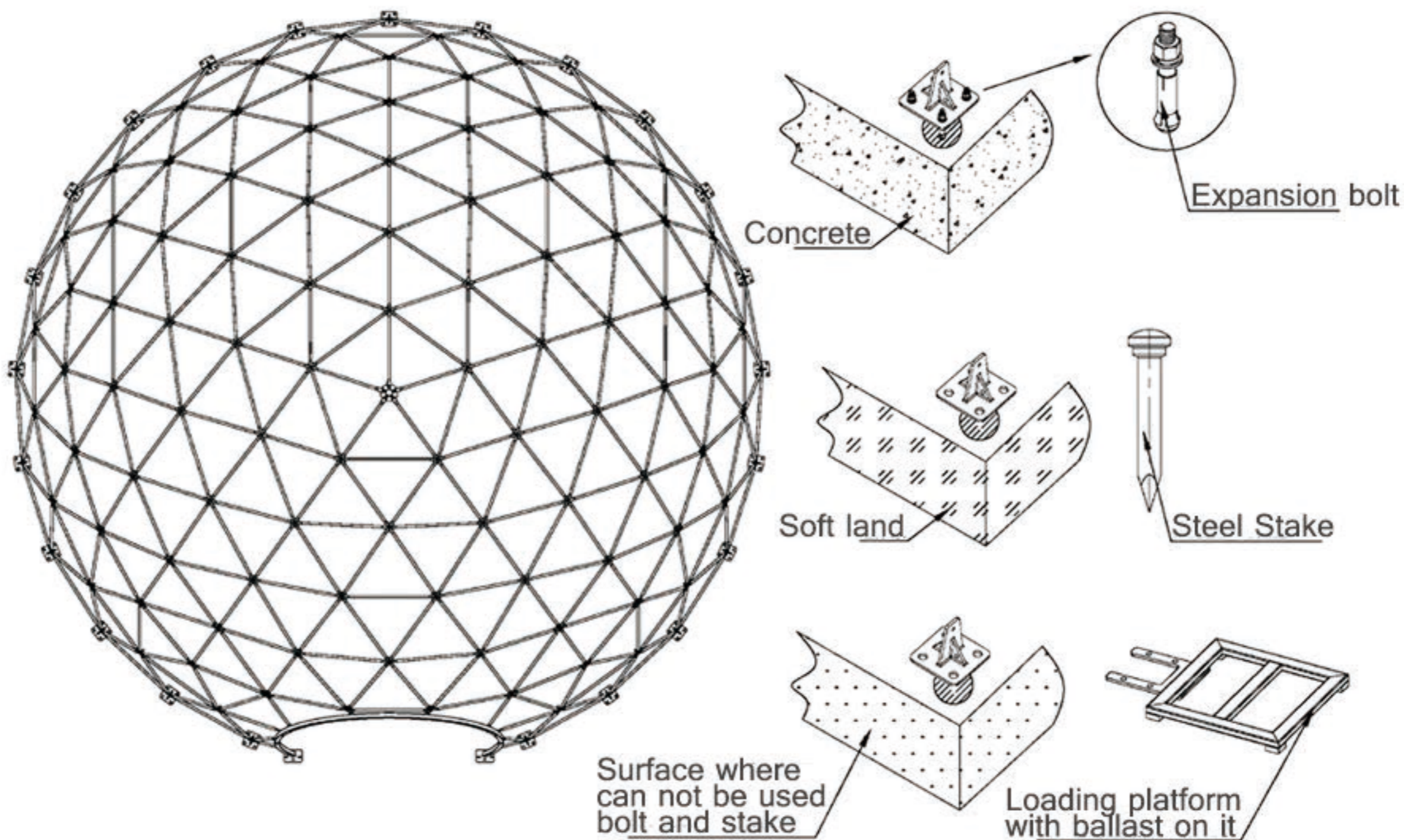

## INSTALLATION STEP

- 8 Now you will pull the membrane on the dome frame. Confirm the entrance in the membrane and the dome frame entrance toward the same direction. You should be careful through the process, making sure the membrane does not tangled between the steel pipes. Simply adjust the cover to the right place if the membrane entrance is not in the same place as the dome entrance.

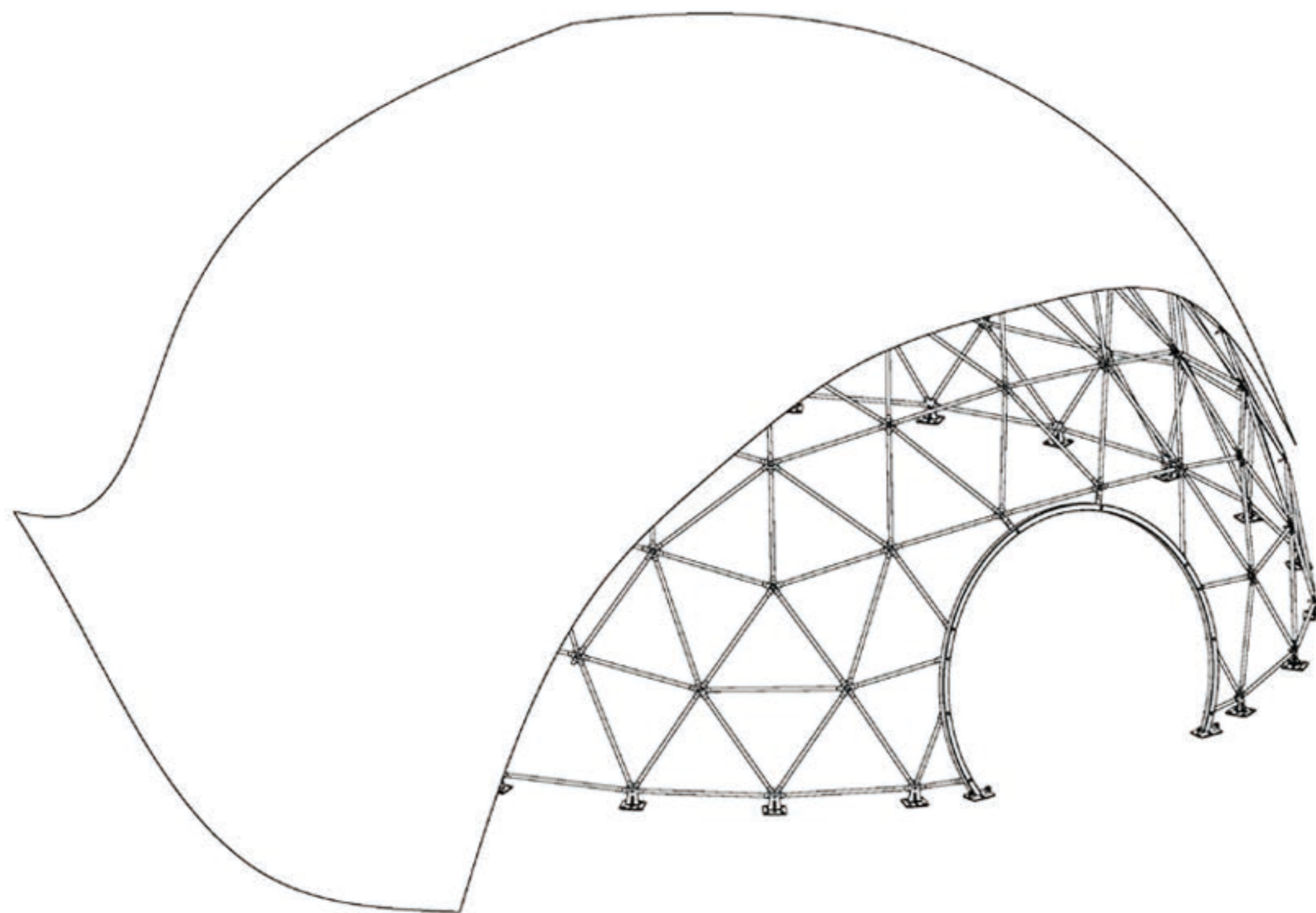

## INSTALLATION STEP

- 9 At the bottom of the membrane, you will find the opening apertures at the white parts. Put the stretch bar into the aperture and leave the hole on the stretch bar out of the membrane.

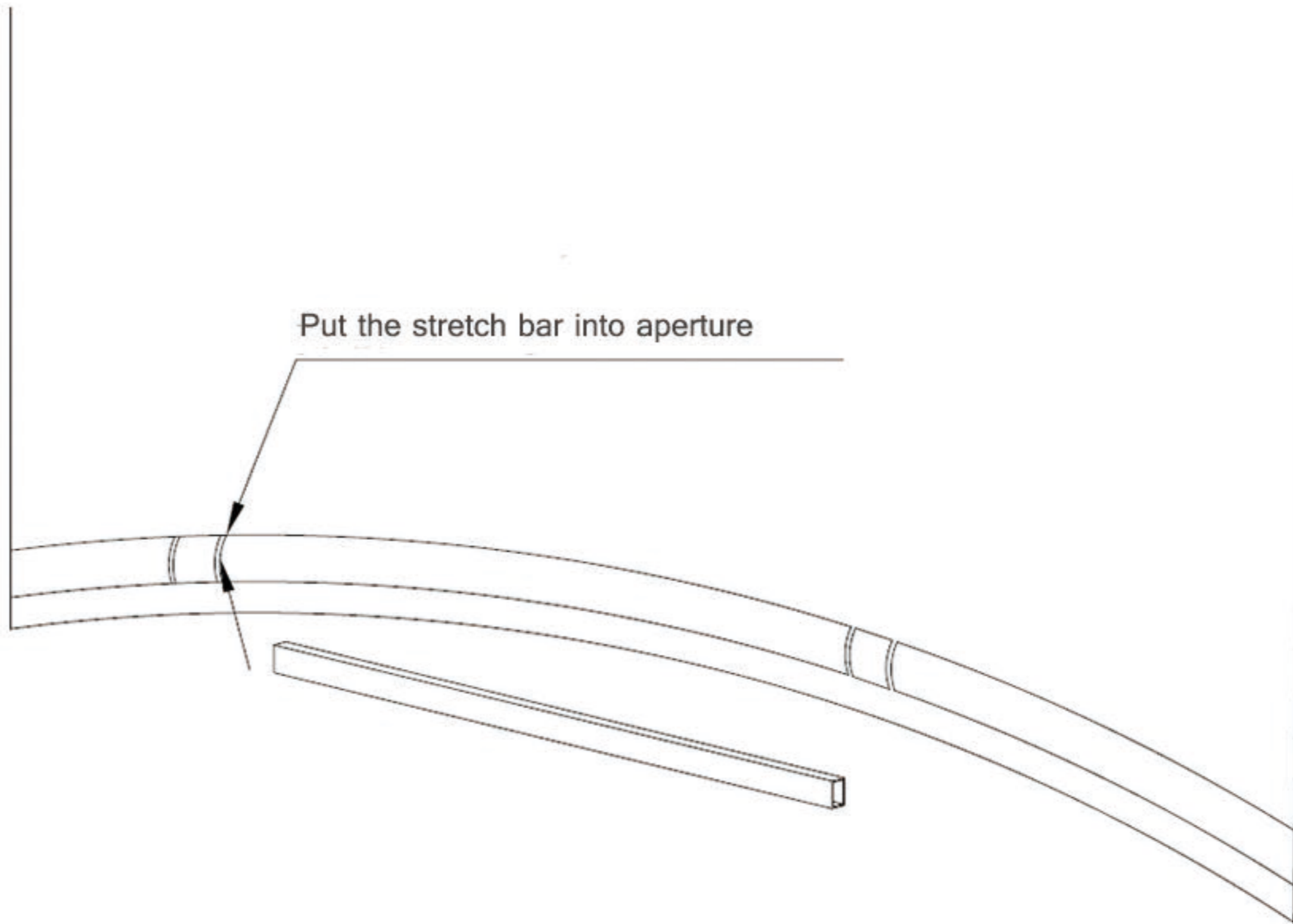

# INSTALLATION STEP

- 10** Use the stretch hooks and hook the bottom horizontal pipes or the holes on base plate (based on the final situation of your dome). Fix to the stretch bar and tight the lead screw with nuts.

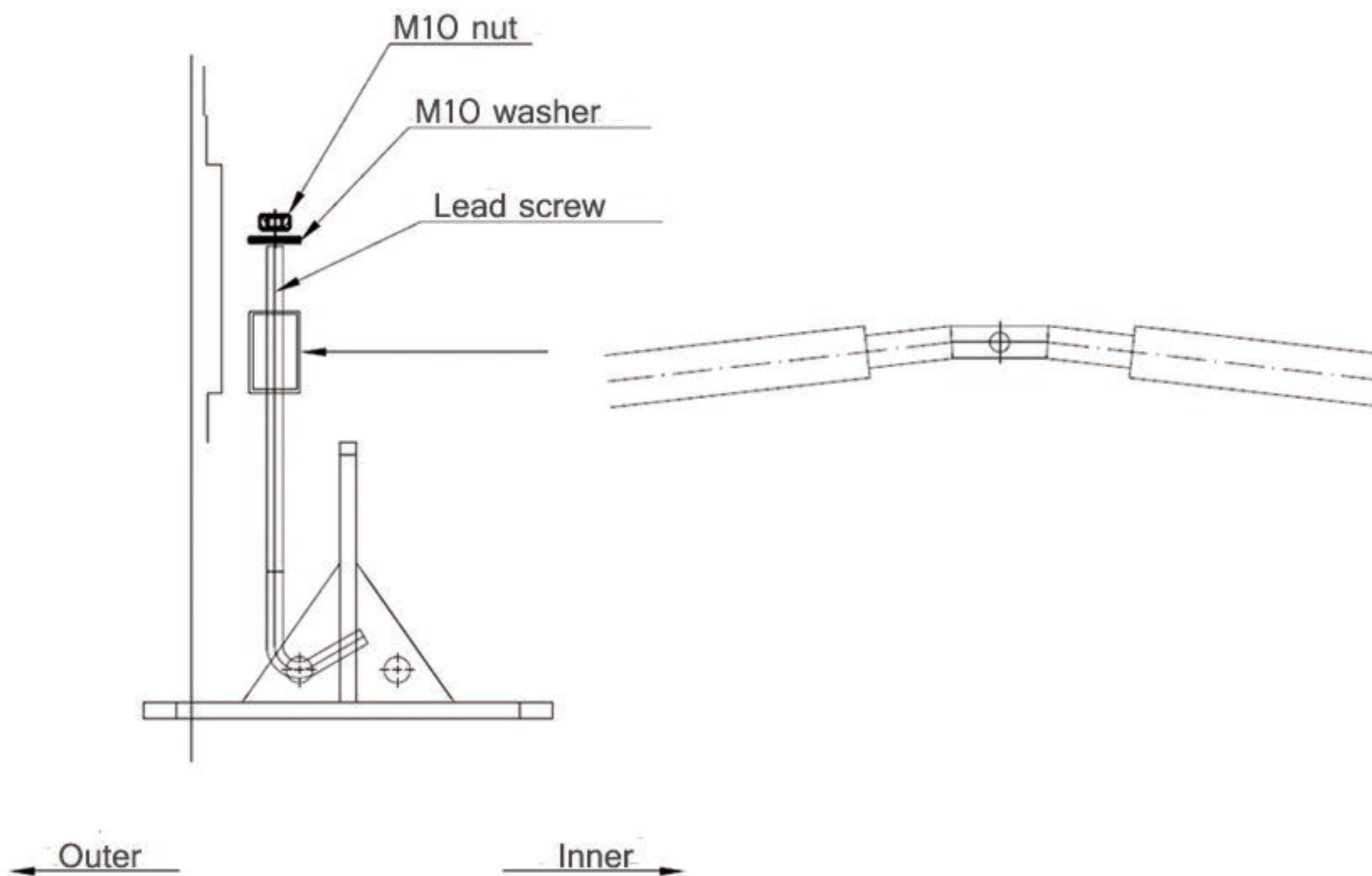

## INSTALLATION STEP

- 11** The last thing to do is to attach the membrane door to the door frame and tight it with the outer membrane. (Note: if you have a rectangular door frame to install, you will need another step - see the step 12.)

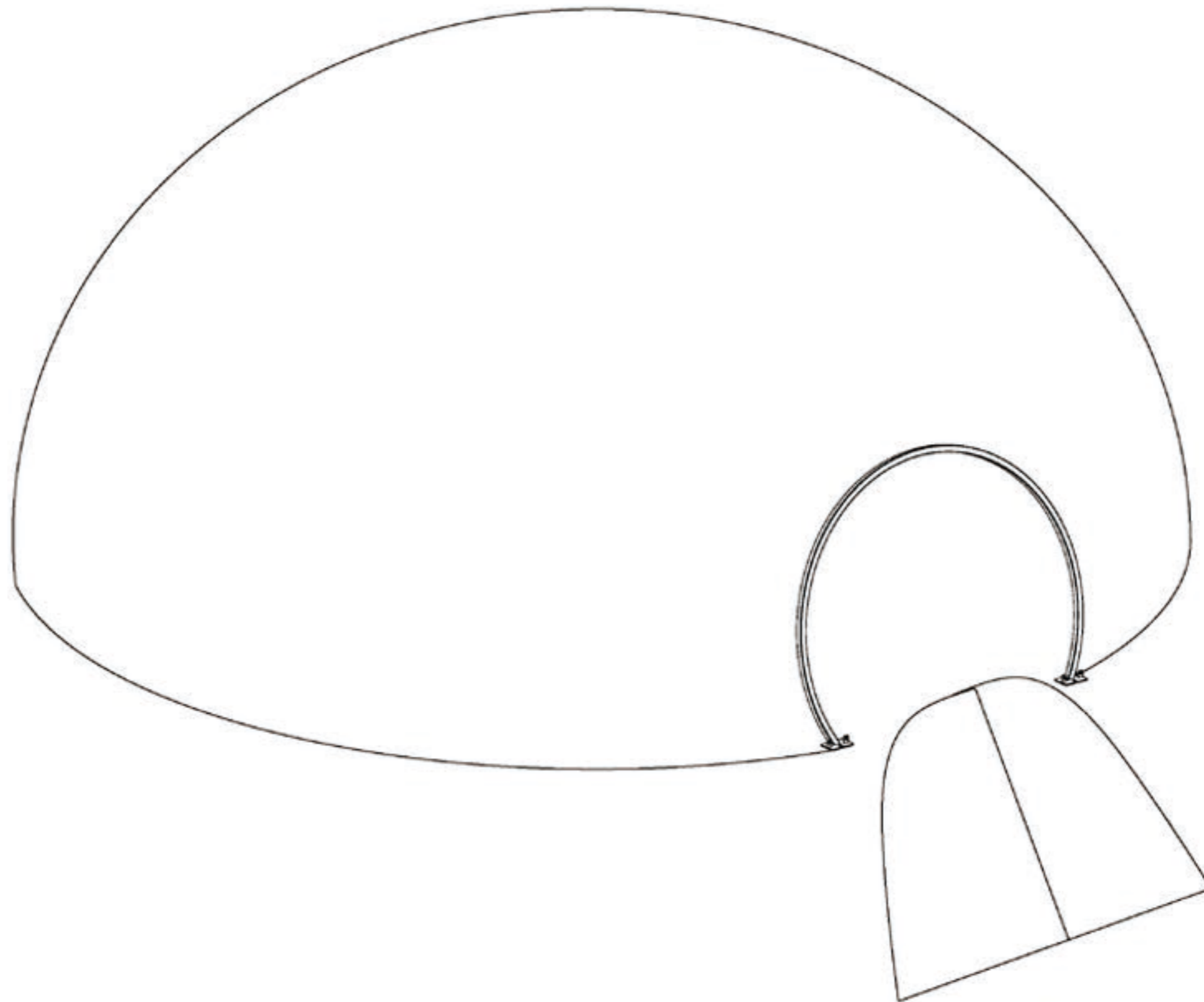

## INSTALLATION STEP

- 12** Tight the outer membrane with the batten plate on the door frame then cut the redundant part. Drill holes on the door frame and install the rectangular door inside the frame with screws. Now you have finished all the installation steps. Enjoy the great time inside your dome!

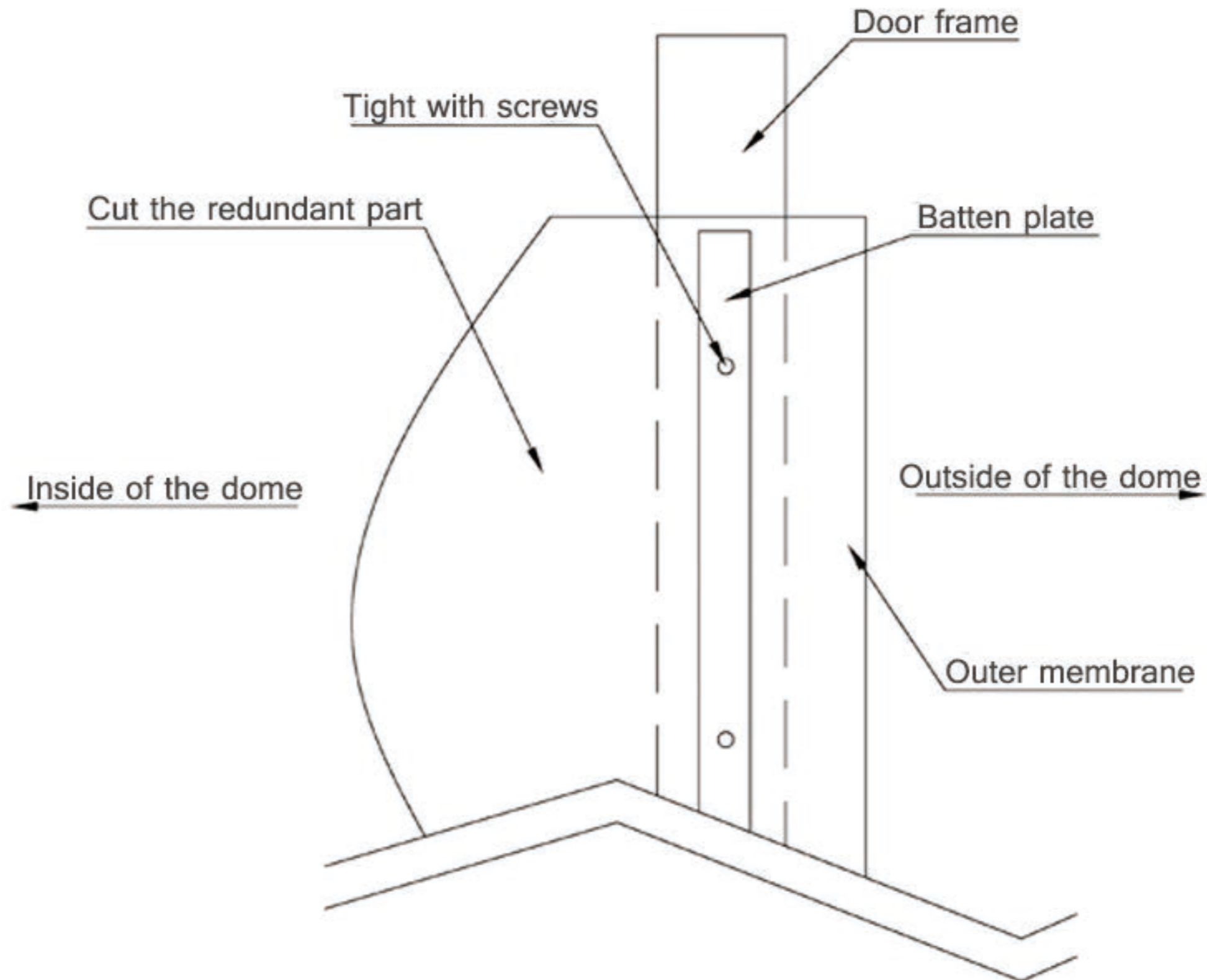



Tel: +8620 6660 3258      Mob/WhatsApp: +86 139 2885 8552  
Email: [admin@shelter-structures.com](mailto:admin@shelter-structures.com)      Web: [www.shelter-dome.com](http://www.shelter-dome.com)  
Add: 1 Songshan Rd, Chaotian Industrial Zone, Panyu, Guangzhou, China

